



SYSTEM
WINNING MOVE

www.wmsystem.com

PROFESSIONAL | LIGHT | FAST



LOADING RAMPS

WE SOLVE ALL YOUR LOADING AND UNLOADING NEEDS,
WITH RAMPS MADE TO MEASURE FOR EVERY TYPE OF VEHICLE.

WM SYSTEM

A HISTORY OF INNOVATION

Since the time of its incorporation, WM System has been delivering adaptable solutions designed to meet people's needs. The development of each WM System product is guided by principles of simplicity, safety and quality along with a commitment to suit the needs of the end user.

The company has grown in line with these strategies, separating its operations into four separate divisions, all of which share the objective of lightening the load. Expanding on our expertise in commercial loading ramps, we have continued to develop products to meet the needs of our customers. With recent expansion into the access ramps sector, we are able to cater for all loading needs while maximising accessibility and promoting personal independence.

The latest model in our product range is called Dynamic. Dynamic is a futuristic mobile workstation designed to revolutionise the concept of mobile service and work. With the same objective of mobility, we developed our series of modular carts, which can be built up as required to facilitate and organise work.

All our products are manufactured in Italy using top quality materials. Genuine Italian design and production are just two of the reasons why our customers place their trust in our company and choose our products time after time. Owing to our passion and commitment to continuous research, we are the European leader in the loading ramps sector. Every year, new customers choose WM System as a reliable partner to help them in their business development process.

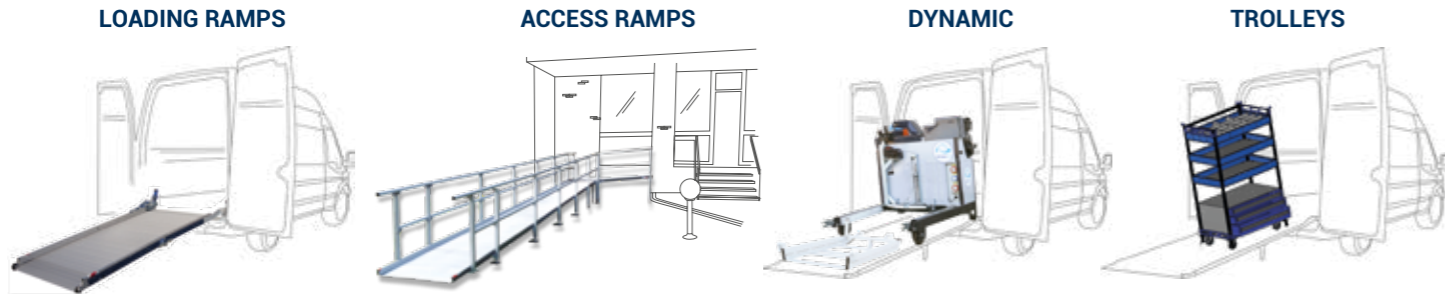

A COMPREHENSIVE SERVICE



BESPOKE TECHNICAL
ADVICE



TAILOR-MADE
DESIGN



100% ITALIAN
PRODUCTION



FAST DELIVERY
TIMES



AFTER-SALES
SERVICE

ALL WM SYSTEM RAMPS HAVE



TÜV QUALITY
CONFIRMATION



TYPE APPROVAL
NOT NEEDED



2 YEAR
WARRANTY



PATENTED
SYSTEM



ITALIAN
ENGINEERING

WHY CHOOSE OUR RAMPS?

FLEXIBILITY

Full range of manual
ramps suitable for all
sectors and all specific
needs

QUALITY

With our in-house welding
and CNC departments, we
can guarantee unbeatable
quality standards. Our
ramps are rugged and
durable

TIME SAVING

Reduced loading and
unloading times, with only a
single operator needed

SAFETY

Managed risks with
safer and better working
environment

THANKS TO OUR WORLDWIDE NETWORK OF DISTRIBUTORS, WE CAN PROVIDE EVERY CUSTOMER WITH CUSTOMISED SUPPORT AND ASSISTANCE

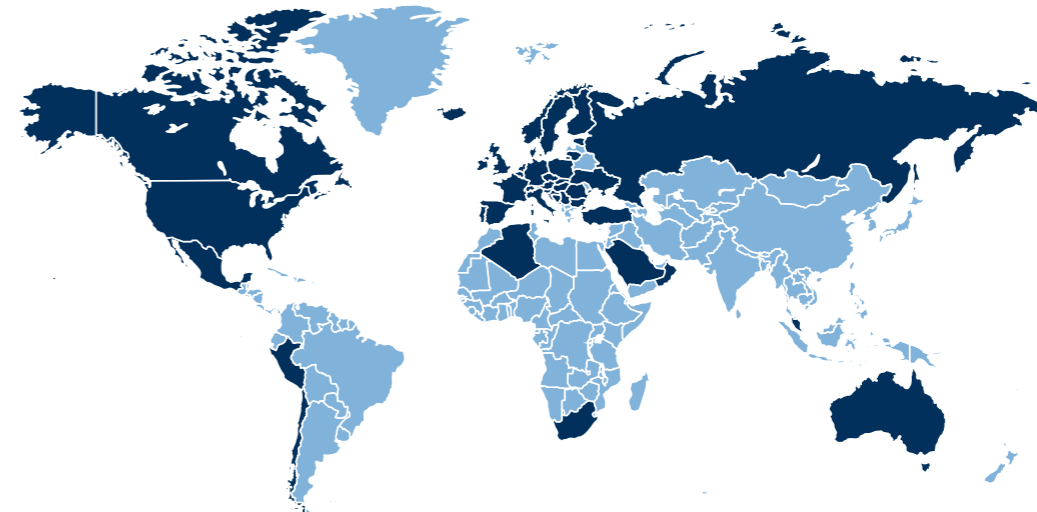

40

COUNTRIES IN WHICH
WE ARE PRESENT

WM PC

LOADING RAMP WITH CAPACITY OF UP TO 1800 KG, SUITABLE FOR LIGHT COMMERCIAL VEHICLES. MORE THAN 500 SIZES AVAILABLE

LOAD CAPACITY: UP TO 1800 KG

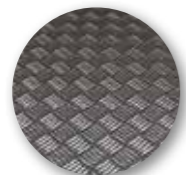

Shot-blasted non-slip aluminium surface



Wheel for assisted deployment



Self-positioning adjustable feet



Mobile contact flap to connect to the floor of the van

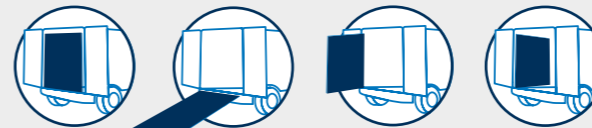

DEPLOYMENT AND CLOSING

The PC is the most complete and practical of WM System's loading ramps. Suitable for most loading and weight requirements, it is extremely practical thanks to the patented horizontal swivel opening. The spring system balances the weight of the ramp during use, allowing it to be handled safely and easily by a single operator.

OPTIONAL EXTRAS



INTERNAL LATCH

Latch to secure the ramp in its fully swivelled position inside the vehicle.

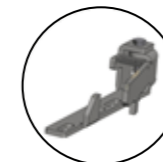

WIND SAFETY KIT

Allows the ramp to be secured when swivelled fully outward. This feature ensures that gusts of wind cannot cause the ramp to rotate, with the risk of striking persons or objects.



SUPPLEMENTARY 3RD PIECE KIT

Reduces the ramp angle and results in three folding ramp sections. Ideal for use with small vehicles. Available with capacities up to 1,000 kg, max. width of 100 cm and fixed length of 80 cm.



REMOVABLE EXTENSION KIT

Third removable piece equipped with wheels, to be added to the ramp when necessary. Available for capacities up to 1500 kg.

APPLICATION SECTORS



CLEANING EQUIPMENT



BUILDING CONSTRUCTION



LAUNDRY TROLLEYS



GARDENING LAWN TRACTORS QUAD BIKES



VENDING MACHINES VIDEO SLOT MACHINES



PALLETS

| EXAMPLE MODELS | A (mm) | L (mm) | L2 (mm) | H (mm) | P (mm) | P1 (mm) | P2 (mm) | Capac. (Kg) | Weight* (Kg) |
|----------------|--------|--------|---------|--------|--------|---------|---------|-------------|--------------|
| PC 90 | 2200 | 1165 | 900 | 1215 | 95 | 250 | 8 | 600 | 81 |
| PC 95 | 2500 | 1215 | 950 | 1365 | 95 | 250 | 8 | 600 | 88 |
| PC 100 | 3000 | 1265 | 1000 | 1615 | 95 | 250 | 8 | 1000 | 106 |
| PC 100 | 3250 | 1265 | 1000 | 1740 | 95 | 250 | 8 | 1500 | 124 |
| PC 105 | 2700 | 1315 | 1050 | 1515 | 95 | 250 | 8 | 600 | 96 |
| PC 110 | 3000 | 1365 | 1100 | 1615 | 95 | 250 | 8 | 1500 | 131 |
| PC 110 | 2500 | 1365 | 1100 | 1365 | 95 | 250 | 8 | 1000 | 106 |
| PC 120 | 2700 | 1465 | 1200 | 1465 | 95 | 250 | 8 | 1000 | 117 |
| PC 120 | 3250 | 1465 | 1200 | 1740 | 95 | 250 | 8 | 1500 | 148 |
| PC 125 | 2800 | 1515 | 1250 | 1515 | 95 | 250 | 8 | 1000 | 128 |
| PC 125 | 3000 | 1515 | 1250 | 1615 | 95 | 250 | 8 | 1500 | 145 |
| PC 130 | 3000 | 1565 | 1300 | 1615 | 95 | 250 | 8 | 1000 | 139 |
| PC 130 | 3250 | 1565 | 1300 | 1740 | 95 | 250 | 8 | 1500 | 159 |
| PC 135 | 3200 | 1615 | 1350 | 1715 | 95 | 250 | 8 | 1500 | 160 |
| PC 135 | 3250 | 1615 | 1350 | 1740 | 95 | 250 | 8 | 1800 | 171 |

* The specified weight does not include the installation kit, which depends on the van (min. 2 kg - max. 7 kg)

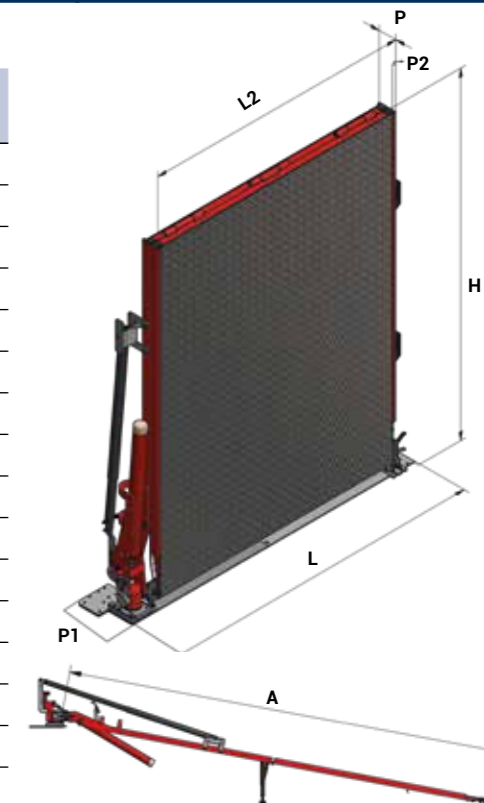

LOAD CAPACITY

600 / 1000 / 1500 / 1800 kg



CUSTOMISED DIMENSIONS

Width from 60 to 137.5 cm
Length from 195 to 325 cm



HANDLING

External and internal swivelling



COLOUR

Red

WM ME

SIMPLE AND ROBUST LOADING RAMP. SUITABLE FOR HEAVY LOADS, CAPACITY FROM 600 KG TO 1800 KG

LOAD CAPACITY: UP TO 1800 KG



LOAD CAPACITY
600 / 1000 / 1500 / 1800 kg



CUSTOMISED DIMENSIONS
Width from 60 to 137.5 cm
Length from 195 to 325 cm



HANDLING
Horizontal deployment



COLOUR
Green

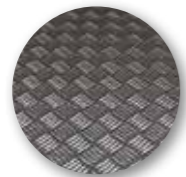

Anti-slip rice-pattern aluminium platform



Wheel for assisted deployment

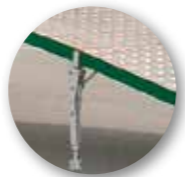

Self-positioning adjustable feet



Mobile contact flap to connect to the floor of the van

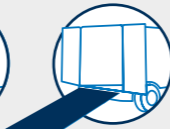
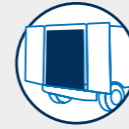

DEPLOYMENT AND CLOSING

The ME ramp is popular for customers needing to load heavy equipment. Deployment of the ramp is simple and quick, thanks to its spring-assisted, fixed vertical, two-section opening. A double-spring version can be supplied on request for larger versions.

OPTIONAL EXTRAS



LEFT HAND SIDE WHEEL KIT

Designed to facilitate ramp deployment, closing and handling. Right hand as standard, or available on left-hand side as an option.



FOLDING SAFETY EDGES

Aluminium safety edges to enhance safety in certain operating conditions.



SUPPLEMENTARY 3RD PIECE KIT

Reduces the ramp angle and results in three folding ramp sections. Ideal for use with small vehicles. Available with capacities up to 1,000 kg, max. width of 100 cm and fixed length of 80 cm.



REMOVABLE EXTENSION KIT

Third removable piece equipped with wheels, to be added to the ramp when necessary. Available for capacities up to 1500 kg, with maximum width of 100 cm.

APPLICATION SECTORS



GARDENING
LAWN
TRACTORS



BUILDING
CONSTRUCTION



QUAD BIKES



CLEANING
MACHINES



PALLET
TRUCKS



PALLETS

| EXAMPLE MODELS | A (mm) | L (mm) | L2 (mm) | H (mm) | P (mm) | P1 (mm) | P2 (mm) | Capac. (Kg) | Weight* (Kg) |
|----------------|--------|--------|---------|--------|--------|---------|---------|-------------|--------------|
| ME 90 | 2200 | 1165 | 900 | 1215 | 95 | 250 | 8 | 600 | 79 |
| ME 95 | 2500 | 1215 | 950 | 1365 | 95 | 250 | 8 | 600 | 86 |
| ME 100 | 3000 | 1265 | 1000 | 1615 | 95 | 250 | 8 | 1000 | 104 |
| ME 100 | 3250 | 1265 | 1000 | 1740 | 95 | 250 | 8 | 1500 | 122 |
| ME 105 | 2700 | 1315 | 1050 | 1515 | 95 | 250 | 8 | 600 | 94 |
| ME 110 | 3000 | 1365 | 1100 | 1615 | 95 | 250 | 8 | 1500 | 129 |
| ME 110 | 2500 | 1365 | 1100 | 1365 | 95 | 250 | 8 | 1000 | 104 |
| ME 120 | 2700 | 1465 | 1200 | 1465 | 95 | 250 | 8 | 1000 | 115 |
| ME 120 | 3250 | 1465 | 1200 | 1740 | 95 | 250 | 8 | 1500 | 146 |
| ME 125 | 2800 | 1515 | 1250 | 1515 | 95 | 250 | 8 | 1000 | 126 |
| ME 125 | 3000 | 1515 | 1250 | 1615 | 95 | 250 | 8 | 1500 | 143 |
| ME 130 | 3000 | 1565 | 1300 | 1615 | 95 | 250 | 8 | 1000 | 137 |
| ME 130 | 3250 | 1565 | 1300 | 1740 | 95 | 250 | 8 | 1500 | 157 |
| ME 135 | 3200 | 1615 | 1350 | 1715 | 95 | 250 | 8 | 1500 | 158 |
| ME 135 | 3250 | 1615 | 1350 | 1740 | 95 | 250 | 8 | 1800 | 169 |

* The specified weight does not include the installation kit, which depends on the van. (min. 2 kg - max. 7 kg)

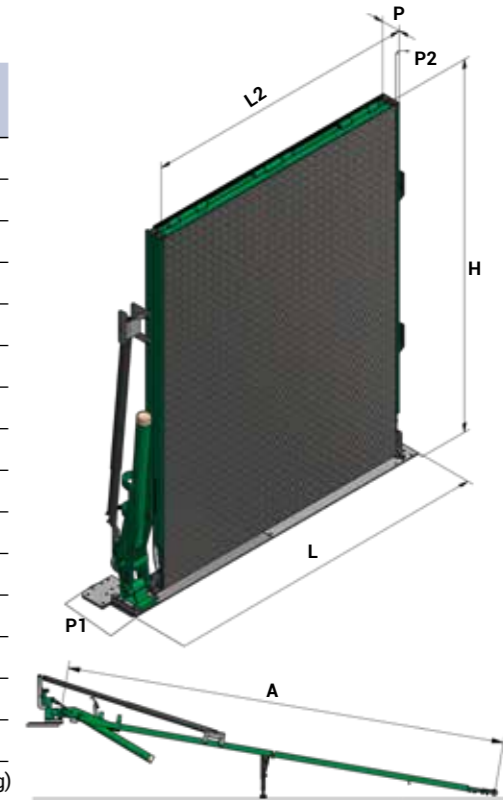

WM PC-R WM ME-R

LOADING RAMP WITH ANTI-SLIP MESH PLATFORM, SUITABLE FOR LOADING EQUIPMENT WITH LARGE TYRED WHEELS

LOAD CAPACITY: UP TO 500 KG

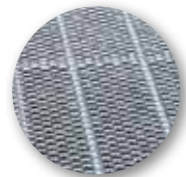

Anti-slip mesh platform

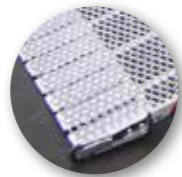

Wheel for assisted deployment



Self-positioning adjustable feet



Mobile contact flap to connect to the floor of the van

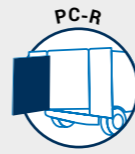

DEPLOYMENT AND CLOSING

The PC-R and ME-R offer excellent grip for loading goods with large, tyred wheels. The galvanised, expanded metal surface is extremely durable and allows for easy cleaning. Both have the patented, spring-assisted vertical opening for ease of use, with the horizontal swivel offered on the PC-R.

OPTIONAL EXTRAS



FOLDING SAFETY EDGES

Aluminium safety edges to enhance safety in certain operating conditions.



SPECIAL FEET

For loading machines with very low ground clearance, special feet can be supplied to create two different ramp slopes for easier ascent. The specified weight does not include the installation kit, which depends on the van. (min. 2kg - max. 7 kg)



SUPPLEMENTARY 3RD PIECE KIT

Reduces the ramp angle and results in three folding ramp sections. Ideal for use with small vehicles. Available with capacities up to 1,000 kg, max. width of 100 cm and fixed length of 80 cm.

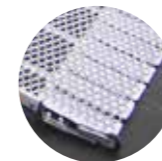

LEFT HAND SIDE WHEEL KIT

Designed to assist the ramp deployment further on to hard ground.

APPLICATION SECTORS



GARDENING
LAWN
TRACTORS



MOTORBIKES
BICYCLES



QUAD BIKES



LOAD CAPACITY
500 kg

CUSTOMISED DIMENSIONS

Width from 60 to 137.5 cm
Length from 195 to 325 cm

HANDLING

PC-R internal-external swivelling
ME-R horizontal deployment

PC-R COLOUR

Blue

ME-R COLOUR

Green

| EXAMPLE MODELS | A (mm) | L (mm) | L2 (mm) | H (mm) | P (mm) | P1 (mm) | P2 (mm) | Capac. (Kg) | Weight* (Kg) |
|----------------|--------|--------|---------|--------|--------|---------|---------|-------------|--------------|
| PC-R/ME-R 90 | 2200 | 1165 | 900 | 1215 | 95 | 250 | 8 | 600 | 80 |
| PC-R/ME-R 95 | 2500 | 1215 | 950 | 1365 | 95 | 250 | 8 | 600 | 87 |
| PC-R/ME-R 100 | 3000 | 1265 | 1000 | 1615 | 95 | 250 | 8 | 1000 | 105 |
| PC-R/ME-R 100 | 3250 | 1265 | 1000 | 1740 | 95 | 250 | 8 | 1500 | 123 |
| PC-R/ME-R 105 | 2700 | 1315 | 1050 | 1515 | 95 | 250 | 8 | 600 | 95 |
| PC-R/ME-R 110 | 3000 | 1365 | 1100 | 1615 | 95 | 250 | 8 | 1500 | 130 |
| PC-R/ME-R 110 | 2500 | 1365 | 1100 | 1365 | 95 | 250 | 8 | 1000 | 105 |
| PC-R/ME-R 120 | 2700 | 1465 | 1200 | 1465 | 95 | 250 | 8 | 1000 | 116 |
| PC-R/ME-R 120 | 3250 | 1465 | 1200 | 1740 | 95 | 250 | 8 | 1500 | 147 |
| PC-R/ME-R 125 | 2800 | 1515 | 1250 | 1515 | 95 | 250 | 8 | 1000 | 127 |
| PC-R/ME-R 125 | 3000 | 1515 | 1250 | 1615 | 95 | 250 | 8 | 1500 | 144 |
| PC-R/ME-R 130 | 3000 | 1565 | 1300 | 1615 | 95 | 250 | 8 | 1000 | 138 |
| PC-R/ME-R 130 | 3250 | 1565 | 1300 | 1740 | 95 | 250 | 8 | 1500 | 158 |
| PC-R/ME-R 135 | 3200 | 1615 | 1350 | 1715 | 95 | 250 | 8 | 1500 | 159 |
| PC-R/ME-R 135 | 3250 | 1615 | 1350 | 1740 | 95 | 250 | 8 | 1800 | 170 |

* The specified weight does not include the installation kit, which depends on the van. (min. 2 kg - max. 7 kg)

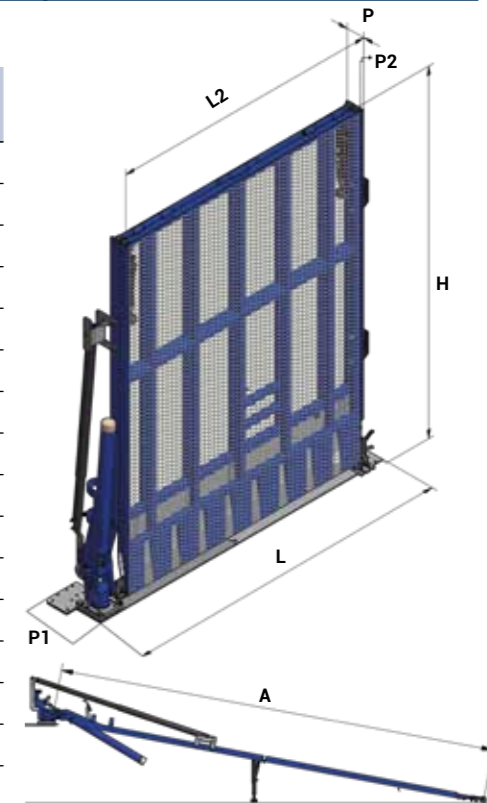

WM LIGHT PLUS

STRONG, LIGHTWEIGHT ALUMINIUM LOADING RAMP FOR LOADS OF UP TO 600 KG. WITH EXTERNAL SWIVEL FUNCTION FOR RAPID ACCESS TO THE VAN'S CARGO AREA.

LOAD CAPACITY: UP TO 600 KG



LOAD CAPACITY
400 kg and 600 kg

CUSTOMISED DIMENSIONS
Width from 40 to 120 cm
Length from 175 to 325 cm

HANDLING
External swivelling

COLOUR
Blue



Anti-slip anodised aluminium platform



Flexible contact plate to the van floor



Two wheels for easy deployment



Safety edges (6 cm)

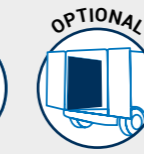
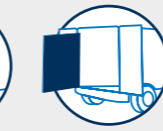
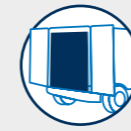

DEPLOYMENT AND CLOSING

The WM Light Plus ramp is constructed from reinforced aluminium making it lightweight and very easy to use due to its patented spring-assisted system. The built-in swivel feature allows the ramp to pivot externally at 90 degrees giving the operator full access to the rear of the vehicle when required. The anti-slip surface provides a safe loading platform with raised lateral anti-fall edges increasing load safety. The ramp can swivel internally with an optional kit.

OPTIONAL EXTRAS



INTERNAL SWIVELLING

Swivel kit that makes it possible to rotate the ramp through 90° toward the interior of the van. Complete with a special latch, to which the ramp is secured inside the van.

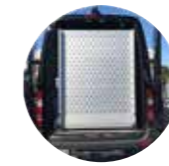

PERFORATED PLATFORM

WM System exclusive platform style. Platform surface in perforated aluminium with alternated convex holes. For maximum grip in the presence of water, rain and snow. Exceptionally light weight.



FLEXIBLE PLATE FOR DOCK-LOADING

By using a supplied pin, the ramp can be locked open to allow dock, or vehicle to vehicle loading at various heights.



SUPPLEMENTARY 3RD PIECE KIT

Reduces the ramp angle and results in 3 folding ramp sections. Ideal for use with small vehicles. Available for load capacities up to 600 kg. Max. width of 100 cm and fixed length of 80 cm.

APPLICATION SECTORS



HEALTHCARE & MEDICAL



CATERING



EVENTS CONCERTS



GENERAL CLEANING EQUIPMENT



MOTORBIKES BICYCLES



LAUNDRY TROLLEYS

| EXAMPLE MODELS | A (mm) | L (mm) | L2 (mm) | H (mm) | P (mm) | P1 (mm) | P2 (mm) | Capac. (Kg) | Weight* (Kg) |
|----------------|--------|--------|---------|--------|--------|---------|---------|-------------|--------------|
| PLUS 80 | 2000 | 1065 | 800 | 1175 | 203 | 250 | 60 | 600 | 71 |
| PLUS 90 | 2250 | 1165 | 900 | 1300 | 203 | 250 | 60 | 600 | 78 |
| PLUS 90 | 2500 | 1165 | 900 | 1425 | 203 | 250 | 60 | 600 | 83 |
| PLUS 95 | 2000 | 1215 | 950 | 1175 | 203 | 250 | 60 | 600 | 76 |
| PLUS 95 | 2750 | 1215 | 950 | 1550 | 203 | 250 | 60 | 600 | 89 |
| PLUS 100 | 2500 | 1265 | 1000 | 1425 | 203 | 250 | 60 | 400 | 87 |
| PLUS 100 | 3000 | 1265 | 1000 | 1675 | 203 | 250 | 60 | 400 | 96 |
| PLUS 100 | 3250 | 1265 | 1000 | 1800 | 203 | 250 | 60 | 400 | 101 |
| PLUS 105 | 2500 | 1315 | 1050 | 1425 | 203 | 250 | 60 | 400 | 89 |
| PLUS 105 | 3000 | 1315 | 1050 | 1675 | 203 | 250 | 60 | 400 | 98 |
| PLUS 110 | 2750 | 1365 | 1100 | 1550 | 203 | 250 | 60 | 400 | 96 |
| PLUS 110 | 3250 | 1365 | 1100 | 1800 | 203 | 250 | 60 | 400 | 106 |
| PLUS 120 | 2500 | 1465 | 1200 | 1425 | 203 | 250 | 60 | 400 | 95 |
| PLUS 120 | 3000 | 1465 | 1200 | 1675 | 203 | 250 | 60 | 400 | 105 |
| PLUS 120 | 3250 | 1465 | 1200 | 1800 | 203 | 250 | 60 | 400 | 111 |

* The specified weight does not include the installation kit, which depends on the van. (min. 2 kg - max. 7 kg)

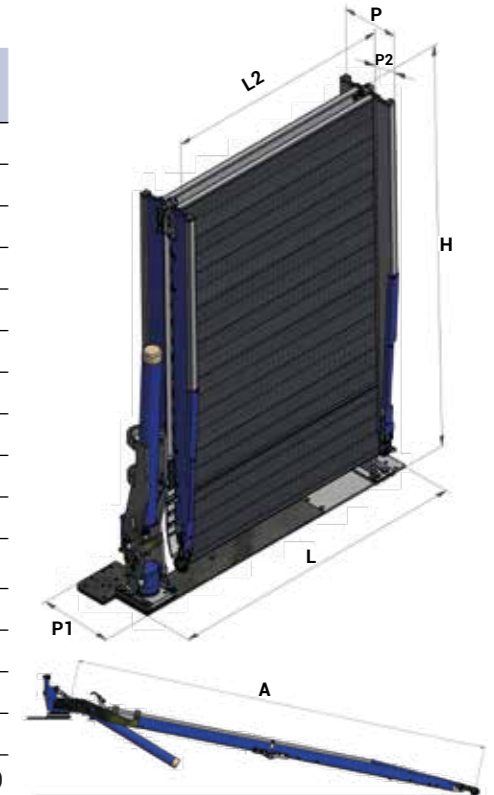

WM LIGHT

DETACHABLE LOADING RAMP. THIS IS THE MOST VERSATILE MODEL IN THE WM RANGE, ESPECIALLY SUITABLE FOR LIGHT LOADS OF UP TO 400 KG.

LOAD CAPACITY: UP TO 400 KG



LOAD CAPACITY
400 kg

CUSTOMISED DIMENSIONS
Width from 40 to 105 cm
Length from 150 to 325 cm

HANDLING
Removable

COLOUR
Blue



Anti-slip anodised aluminium platform



Flexible contact plate to the van floor



Two wheels for easy deployment



Quick release and coupling

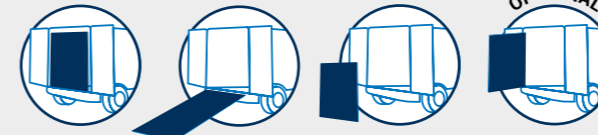

DEPLOYMENT: The WM Light is extremely lightweight, using both spring and gas strut assistance. An external swivel kit is supplied on request, making it possible to gain access to the van like a second door.

DETACHABLE AND VERSATILE: Quick release handles allow for easy removal of the ramp, leaving the load area unobstructed. The keyhole locating plates allow for easy and quick transfer between vehicles.

OPTIONAL EXTRAS



EXTERNAL SWIVELLING

Swivel kit that makes it possible to rotate the ramp through 90° toward the exterior of the van. Allows access to the van's cargo area without using the ramp.

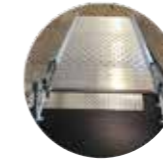

FIXED INSTALLATION

A fixed base can be mounted to the ramp on request. This means the ramp becomes fixed and can no longer be removed from the van. This solution simplifies and streamlines installation operations. The specified weight does not include the installation kit, 5 kg. The external swivelling optional weighs +6 kg.



GANGWAY CONFIGURATION

Thanks to a special pin that locks the hinge, the ramp can be used in gangway mode to connect two surfaces at different heights (vehicles and steps, loading docks, etc...)

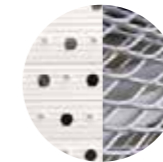

PLATFORM VERSIONS

The ramp is available with a platform surface in perforated aluminium with alternated convex holes, WM LIGHT-F model. This improves the platform's anti-slip properties while retaining the 400 kg load capacity. An aluminium extended mesh version, known as WM LIGHT-R, is available as an alternative. Max. load capacity: 300 kg.

APPLICATION SECTORS



CLEANING EQUIPMENT



CATERING



MOTORBIKES BICYCLES



ELECTRICIANS PLUMBING AND HEATING ENGINEERS



MEDICAL AMBULANCES



EVENTS CONCERTS

| EXAMPLE MODELS | A (mm) | L (mm) | L2 (mm) | H (mm) | P (mm) | P1 (mm) | P2 (mm) | Capac. (Kg) | Weight* (Kg) |
|----------------|--------|--------|---------|--------|--------|---------|---------|-------------|--------------|
| LIGHT 60 | 2000 | 900 | 600 | 1090 | 203 | 345 | 60 | 400 | 46 |
| LIGHT 65 | 2250 | 950 | 650 | 1215 | 203 | 345 | 60 | 400 | 51 |
| LIGHT 70 | 2000 | 1000 | 700 | 1090 | 203 | 345 | 60 | 400 | 49 |
| LIGHT 75 | 2500 | 1050 | 750 | 1340 | 203 | 345 | 60 | 400 | 58 |
| LIGHT 80 | 2750 | 1100 | 800 | 1465 | 203 | 345 | 60 | 400 | 64 |
| LIGHT 80 | 3000 | 1100 | 800 | 1590 | 203 | 345 | 60 | 400 | 68 |
| LIGHT 80 | 3250 | 1100 | 800 | 1715 | 203 | 345 | 60 | 400 | 72 |
| LIGHT 85 | 2500 | 1150 | 850 | 1340 | 203 | 345 | 60 | 400 | 62 |
| LIGHT 85 | 3250 | 1150 | 850 | 1715 | 203 | 345 | 60 | 400 | 75 |
| LIGHT 90 | 3000 | 1200 | 900 | 1590 | 203 | 345 | 60 | 400 | 73 |
| LIGHT 95 | 2750 | 1250 | 950 | 1465 | 203 | 345 | 60 | 400 | 71 |
| LIGHT 100 | 2500 | 1300 | 1000 | 1340 | 203 | 345 | 60 | 400 | 68 |
| LIGHT 100 | 2750 | 1300 | 1000 | 1465 | 203 | 345 | 60 | 400 | 73 |
| LIGHT 100 | 3000 | 1300 | 1000 | 1590 | 203 | 345 | 60 | 400 | 78 |
| LIGHT 105 | 3250 | 1350 | 1050 | 1715 | 203 | 345 | 60 | 400 | 85 |

* The specified weight does not include the installation kit, 5 kg. The external swivelling optional weighs +6 kg

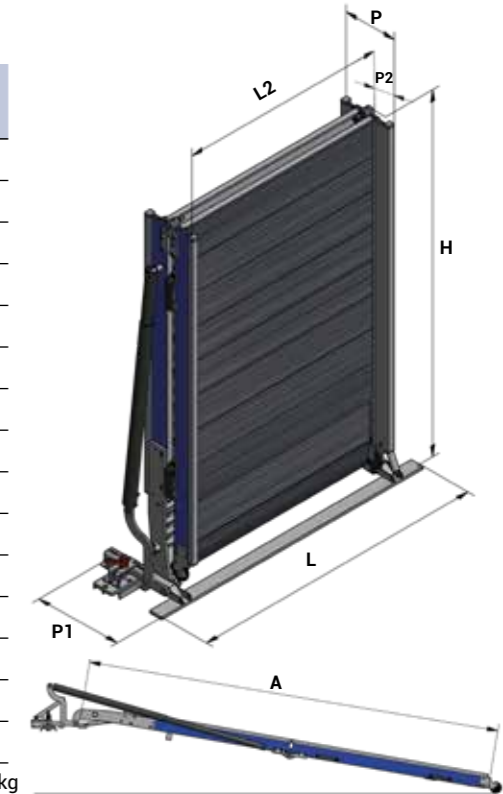

WM EASY

LOADING RAMP WITH LATERAL POSITIONING, AGILE AND EASY TO USE. LEAVES THE VAN'S CARGO AREA UNOBSTRUCTED AT ALL TIMES.

LOAD CAPACITY: UP TO 300 KG



Anti-slip anodised aluminium perforated platform



Lateral positioning for minimum space requirements



Safety edges



Flexible contact plate to the van floor

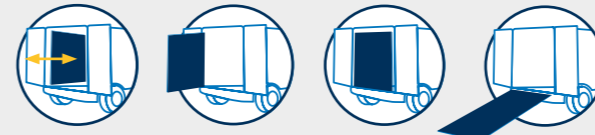

DEPLOYMENT AND CLOSING

Designed with the evolving light commercial vehicle market in mind, the innovative WM EASY enhances our range. The EASY has the unique feature of being able to both swivel and slide out of the way as needed, leaving maximum space in the loading area. This ramp is popular with customers using side loading doors.

OPTIONAL EXTRAS

RIGHT-HAND VERSION

On request, the ramp can be mounted to the right-hand side of the van, inverting the swivel direction. It is also possible to open the ramp in the vertical direction, like a second door. This system makes it possible to gain access to the van's cargo area without using the ramp.



APPLICATION SECTORS



MEDICAL AMBULANCES



MOBILITY PASSENGER TRANSPORT



COURIERS EQUIPMENT HIRE FIRMS

UNOBSTRUCTED CARGO AREA:

- LATERAL POSITIONING
- ACCESS ALWAYS UNOBSTRUCTED
- NO OBSTACLES ON PLATFORM

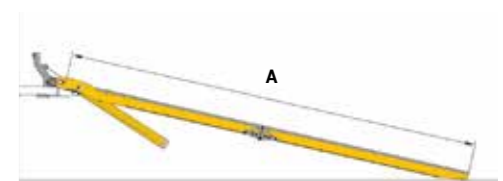
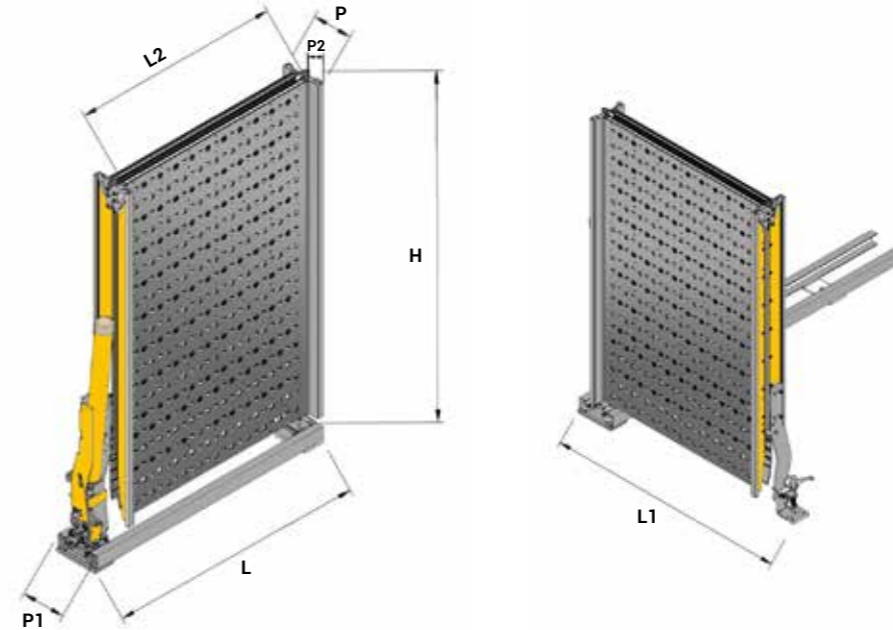

| ALL MODELS | A (mm) | L (mm) | L1 (mm) | L2 (mm) | H (mm) | P (mm) | P1 (mm) | P2 (mm) | Capac. (kg) | Weight* (kg) |
|------------|--------|--------|---------|---------|--------|--------|---------|---------|-------------|--------------|
| EASY | 2000 | 1170 | 1180 | 800 | 1180 | 155 | 250 | 45 | 300 | 71 |
| EASY | 2250 | 1170 | 1180 | 800 | 1305 | 155 | 250 | 45 | 300 | 74 |
| EASY | 2500 | 1170 | 1180 | 800 | 1430 | 155 | 250 | 45 | 300 | 78 |
| EASY | 2750 | 1170 | 1180 | 800 | 1555 | 155 | 250 | 45 | 300 | 81 |
| EASY | 3000 | 1170 | 1180 | 800 | 1680 | 155 | 250 | 45 | 300 | 85 |

* The specified weight includes the installation kit.

WM SUPERLIGHT

REMOVABLE, LIGHT-WEIGHT AND PRACTICAL LOADING RAMP WITH ANODISED ALUMINIUM ANTI-SLIP PLATFORM.

LOAD CAPACITY: UP TO 250 KG



Anti-slip aluminium platform with relief pattern



Safety edges (6 cm)



Gas strut for easy handling



Quick release and coupling.



DEPLOYMENT: The WM Superlight is extremely lightweight, using both spring and gas strut assistance. An external swivel kit is supplied on request, making it possible to gain access to the van like a second door.

REMOVABILITY AND TRANSPORT: Quick release handles allow for easy removal of the ramp, leaving the load area unobstructed. The keyhole locating plates allow for easy and quick transfer between vehicles.

OPTIONAL EXTRAS



FIXED INSTALLATION

A fixed base can be mounted to the ramp on request. This means the ramp becomes fixed and can no longer be removed from the van. This solution simplifies and streamlines installation operations.



EXTERNAL SWIVELLING

Swivel kit that makes it possible to rotate the ramp through 90° toward the exterior of the van. This system makes it possible to gain access to the van's cargo area without using the ramp (e.g. for loading pallets with a forklift truck).

APPLICATION SECTORS



MEDICAL AMBULANCES



DISABLED USERS PASSENGER TRANSPORT

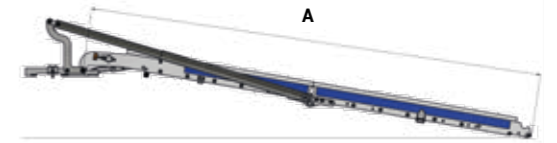
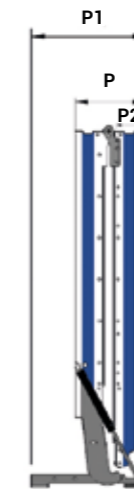
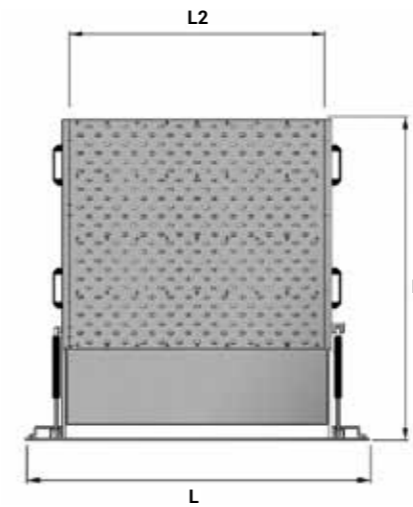

| ALL MODELS | A (mm) | L (mm) | L2 (mm) | H (mm) | P (mm) | P1 (mm) | P2 (mm) | Capac. (kg) | Weight* (kg) |
|------------|--------|--------|---------|--------|--------|---------|---------|-------------|--------------|
| SUPERLIGHT | 2000 | 1100 | 850 | 1085 | 215 | 345 | 60 | 250 | 40 |
| SUPERLIGHT | 2250 | 1100 | 850 | 1210 | 215 | 345 | 60 | 250 | 45 |
| SUPERLIGHT | 2500 | 1100 | 850 | 1335 | 215 | 345 | 60 | 250 | 50 |

* The specified weight does not include the installation kit, 5 kg. The external swivelling optional weighs +6 kg

WM MOBILE

MOBILE LOADING RAMP. THE RAMP FOLDS INTO 2 SO IT CAN BE EASILY TRANSPORTED, AND IT FEATURES REST-ON TYPE DESIGN SO IT DOES NOT REQUIRE ANY INSTALLATION OPERATIONS.

LOAD CAPACITY: UP TO 300 KG



Aluminium anti-slip platform



Adjustable floor contact flap



Safety edges (5 cm)



Four wheels and two handles for easy transport



LOAD CAPACITY
300 kg



CUSTOMISED DIMENSIONS
Width from 30 to 100 cm
Length from 150 to 325 cm



HANDLING
Mobile



COLOUR
Green

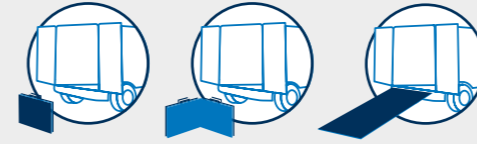

REMOVABILITY AND TRANSPORT

Mobile ramp without installation requirements: simply rests on the van floor. The special rest-on system is adjustable and features 4 alternative positions for perfect adaptation to different vehicle heights.

OPTIONAL EXTRAS



ANODISED PLATFORM

For enhanced durability and aesthetics, the aluminium ramp can be supplied with an anodised surface treatment.



ONE-PIECE RAMP

The central hinges can be locked to obtain a non-folding one-piece ramp.

APPLICATION SECTORS



GENERAL CLEANING



ELECTRICIANS
PLUMBING
AND HEATING
ENGINEERS



MOTORBIKES
BICYCLES



EVENTS
CONCERTS

| EXAMPLE MODELS | A (mm) | L (mm) | L1 (mm) | L2 (mm) | H (mm) | P (mm) | P2 (mm) | Capac. (kg) | Weight (kg) |
|----------------|--------|--------|---------|---------|--------|--------|---------|-------------|-------------|
| MOBILE 40 | 1750 | 536 | 465 | 400 | 905 | 155 | 45 | 300 | 21 |
| MOBILE 50 | 2250 | 636 | 565 | 500 | 1155 | 155 | 45 | 300 | 29 |
| MOBILE 60 | 2500 | 736 | 665 | 600 | 1280 | 155 | 45 | 300 | 35 |
| MOBILE 65 | 2750 | 786 | 715 | 650 | 1405 | 155 | 45 | 300 | 40 |
| MOBILE 70 | 3000 | 836 | 765 | 700 | 1530 | 155 | 45 | 300 | 45 |
| MOBILE 70 | 2000 | 836 | 765 | 700 | 1030 | 155 | 45 | 300 | 32 |
| MOBILE 75 | 2500 | 886 | 815 | 750 | 1280 | 155 | 45 | 300 | 40 |
| MOBILE 80 | 2000 | 936 | 865 | 800 | 1030 | 155 | 45 | 300 | 28 |
| MOBILE 80* | 2500 | 936 | 865 | 800 | 1280 | 155 | 45 | 300 | 33 |
| MOBILE 80* | 3000 | 936 | 865 | 800 | 1530 | 155 | 45 | 300 | 39 |
| MOBILE 80* | 3250 | 936 | 865 | 800 | 1655 | 155 | 45 | 300 | 53 |
| MOBILE 85 | 2000 | 986 | 915 | 850 | 1030 | 155 | 45 | 300 | 37 |
| MOBILE 90 | 3000 | 1036 | 965 | 900 | 1530 | 155 | 45 | 300 | 54 |
| MOBILE 100 | 2500 | 1136 | 1065 | 1000 | 1280 | 155 | 45 | 300 | 49 |
| MOBILE 100 | 3000 | 1136 | 1065 | 1000 | 1530 | 155 | 45 | 300 | 58 |

* lightweight version

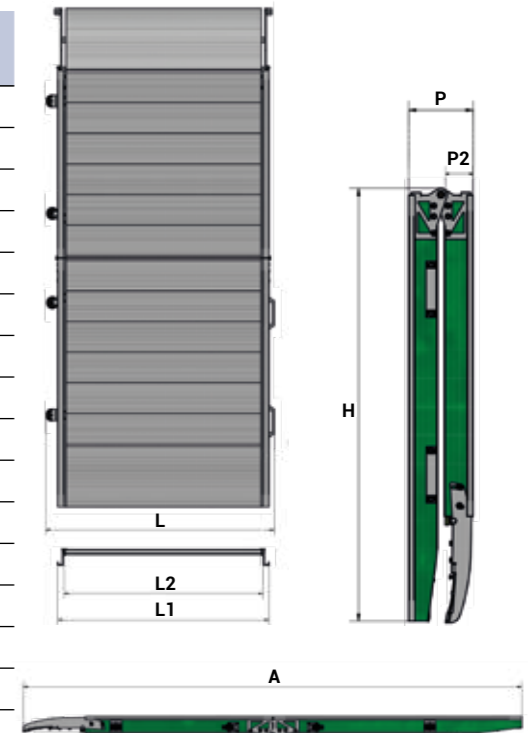

WM TELESCOPIC

PRACTICAL, EASY TO USE MOBILE TELESCOPIC RAMP. IN PERFORATED ANTI-SLIP ALUMINIUM WITH SAFETY EDGES.

LOAD CAPACITY: UP TO 300 KG PER PAIR OF RAMPS



LOAD CAPACITY
300 kg per pair

STANDARD DIMENSIONS
Width 18.5 cm
Length 150, 200, 225, 250 and 300 cm

HANDLING
Mobile

COLOUR
Yellow



REMOVABILITY AND TRANSPORT

The WM Telescopic is unique in the way it can be extended to the required length. This ramp offers a rest-on, folding contact plate for safe and secure loading. These can be supplied individually or as a pair as required.

OPTIONAL EXTRAS



ECO VERSION

ECO version also available: unperforated loading platform, without taper in the contact flap and without yellow colour on safety edges.

APPLICATION SECTORS



DISABLED USERS PASSENGER TRANSPORT
MOTORBIKES BICYCLES
MEDICAL AMBULANCES

CONTACT FLAP:

- TAPERED
- WITH 4 HEIGHT SETTINGS
- REST-ON (20 CM CONTACT LENGTH ON PLATFORM)
- FOLDING

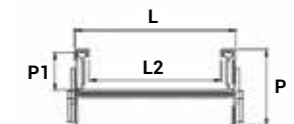
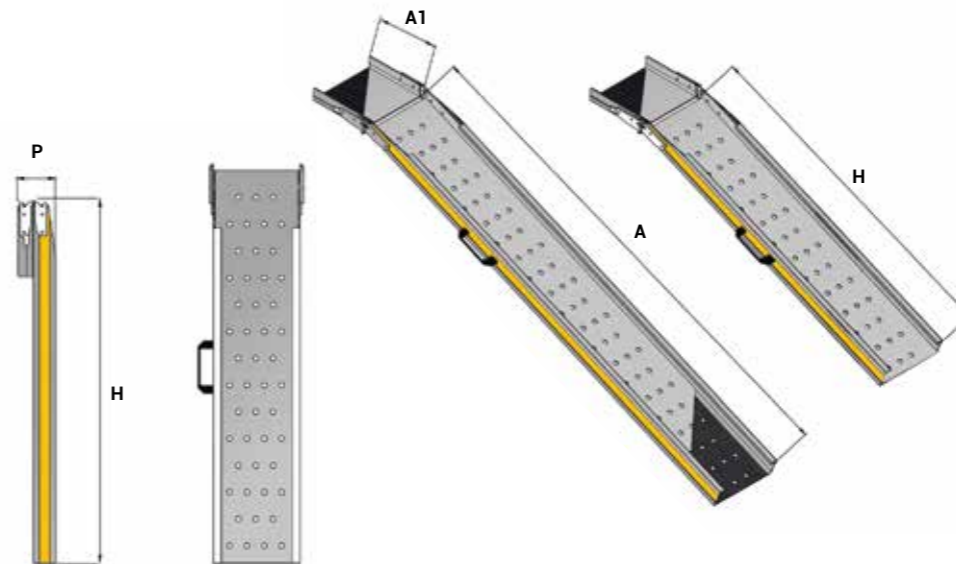

| ALL MODELS | A (mm) | A1 (mm) | L (mm) | L2 (mm) | H (mm) | P (mm) | P1 (mm) | Load capacity per pair (kg) | Weight (kg) |
|---------------|--------|---------|--------|---------|--------|--------|---------|-----------------------------|-------------|
| WM TELESCOPIC | 1500 | 200 | 225 | 185 | 900 | 106 | 55 | 300 | 5 |
| WM TELESCOPIC | 2000 | 200 | 225 | 185 | 1150 | 106 | 55 | 300 | 6 |
| WM TELESCOPIC | 2250 | 200 | 225 | 185 | 1275 | 106 | 55 | 300 | 6,5 |
| WM TELESCOPIC | 2500 | 200 | 225 | 185 | 1400 | 106 | 55 | 300 | 7 |
| WM TELESCOPIC | 3000 | 200 | 225 | 185 | 1650 | 106 | 55 | 300 | 8 |

A RAMP FOR EVERY NEED



A WORLD FULL OF SOLUTIONS



WM SYSTEM S.r.l.
BUSINESS PREMISES - Via Campogrande 94/96
REGISTERED OFFICE - Via 2 Giugno, 5
42047 ROLO (Reggio Emilia) - ITALY
Tel. +39 0522 665664 - Fax +39 0522 660327 - info@wmsystem.com

www.wmsystem.com

